

**Square Washer**

**FP100**

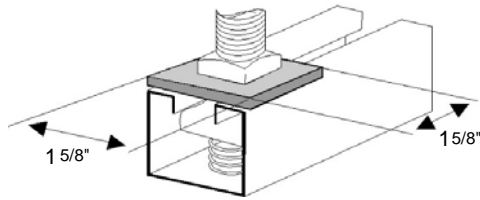

PART No.	ROD SIZE	Hole Dia.	Wt. Per 100
FP100-1/4	1/4"	5/16"	19#
FP100-5/16	5/16"	3/8"	18#
FP100-3/8	3/8"	7/16"	18#
FP100-1/2	1/2"	9/16"	17#
FP100-5/8	5/8"	11/16"	16#
FP100-3/4	3/4"	13/16"	15#

Std. Pkg.  
100 Pcs.

**No-Turn Washer**

**FP101**

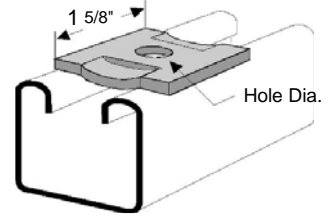

PART No.	ROD SIZE	Hole Dia.	Wt. Per 100
FP101-1/4	1/4"	5/16"	19#
FP101-5/16	5/16"	3/8"	18#
FP101-3/8	3/8"	7/16"	18#
FP101-1/2	1/2"	9/16"	17#
FP101-5/8	5/8"	11/16"	16#
FP101-3/4	3/4"	13/16"	15#

Std. Pkg.  
100 Pcs.

**Two-Hole Splice Plate**

**FP200**

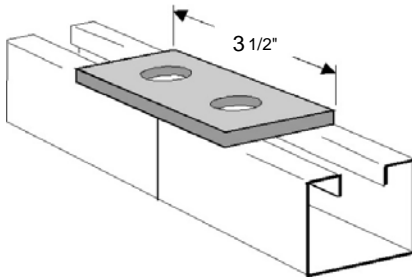

Wt./C 37 Lbs.  
Std. Pkg. 50 Pcs.

**Two-Hole Splice Plate**

**FP201**

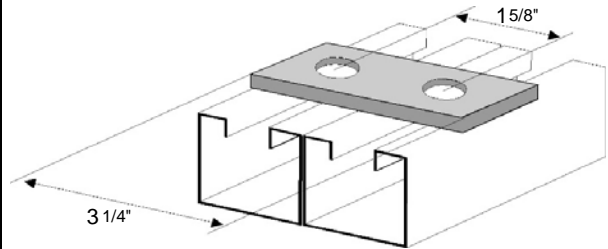

Wt./C 34 Lbs.  
Std. Pkg. 50 Pcs.

**Two-Hole Splice Plate**

**FP202**

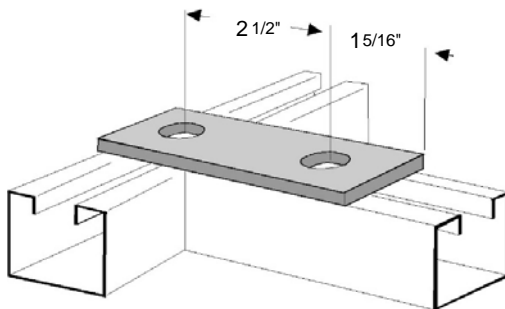

Wt./C 50 Lbs.  
Std. Pkg. 25 Pcs.

**Three-Hole Splice Plate**

**FP300**

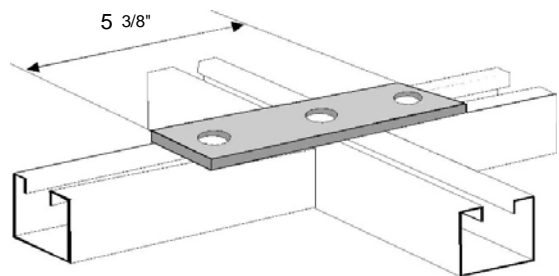

Wt./C 55 Lbs.  
Std. Pkg. 25 Pcs.

**FITTING SPECIFICATIONS** (unless noted): Hole Size-9/16" Diameter; Hole Spacing-13/16" from end and 1 7/8" on center.  
Width-1 5/8"; Thickness 1/4"

**FINISHES AVAILABLE:** Zinc Plated, Hot-Dipped Galvanized & Stainless Steel

**Four-Hole Splice Plate FP400**

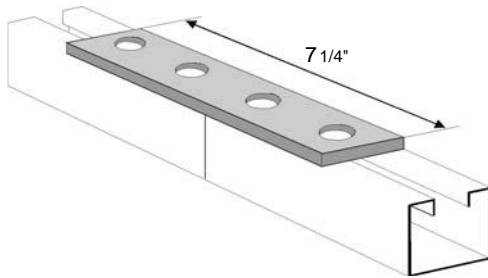

Wt./C 76 Lbs.  
Std. Pkg. 25 Pcs.

**Five-Hole Splice Plate FP401**

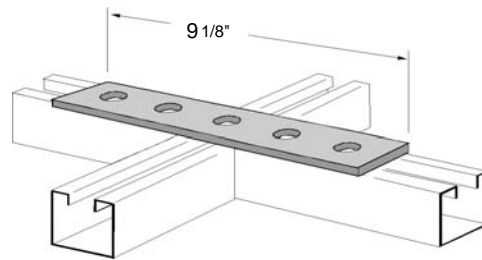

Wt./C 96 Lbs.  
Std. Pkg. 20 Pcs.

**Four-Hole Splice Plate FP402**

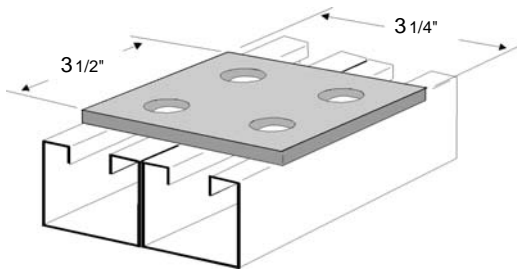

Wt./C 73 Lbs.  
Std. Pkg. 25 Pcs.

**Three-Hole Corner Plate FP500**

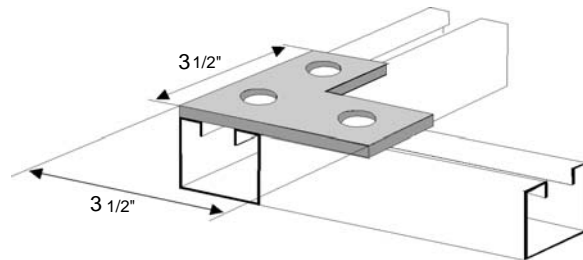

Wt./C 56 Lbs.  
Std. Pkg. 25 Pcs.

**Three-Hole Corner Gusset FP501**

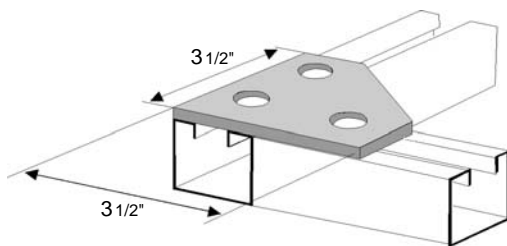

Wt./C 70 Lbs.  
Std. Pkg. 25 Pcs.

**Three-Hole Tee Gusset FP502**

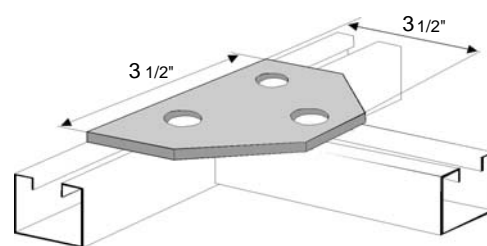

Wt./C 70 Lbs.  
Std. Pkg. 25 Pcs.

**FITTING SPECIFICATIONS** (unless noted): Hole Size-9/16" Diameter; Hole Spacing-13/16" from end and 1 7/8" on center.  
Width-1 5/8"; Thickness 1/4"

**FINISHES AVAILABLE:** Zinc Plated, Hot-Dipped Galvanized & Stainless Steel

**Four-Hole Tee Plate** **FP600**

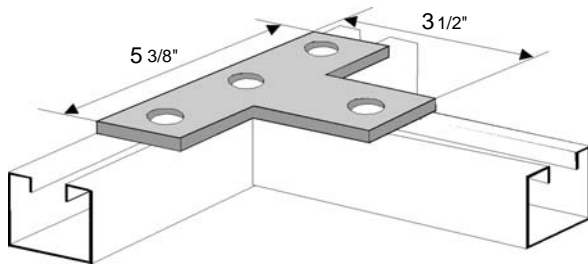

Wt./C 75 Lbs.  
Std. Pkg. 20 Pcs.

**Four-Hole Tee Gusset** **FP601**

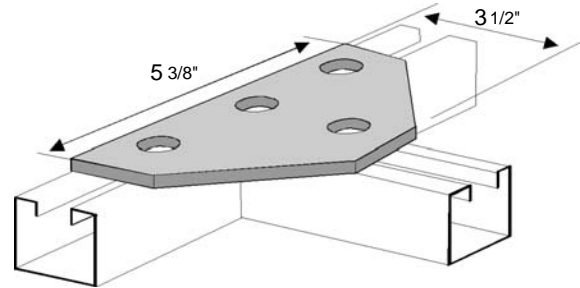

Wt./C 100 Lbs.  
Std. Pkg. 25 Pcs.

**Four-Hole Tee Gusset** **FP602**

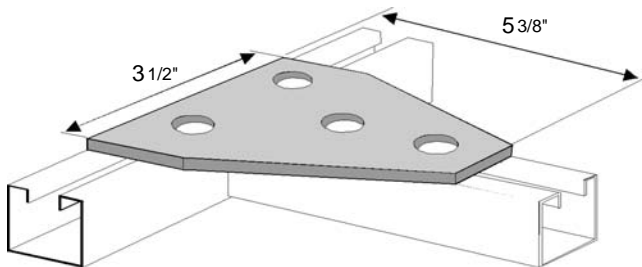

Wt./C 100 Lbs.  
Std. Pkg. 20 Pcs.

**Four-Hole Corner Gusset** **FP603**

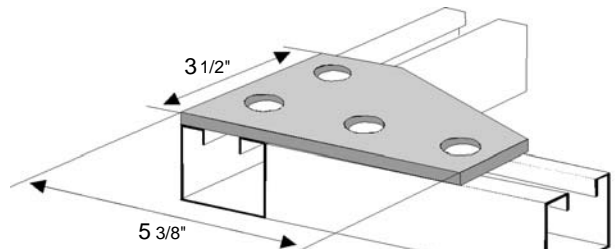

Wt./C 102 Lbs.  
Std. Pkg. 25 Pcs.

**Four-Hole Corner Plate** **FP604**

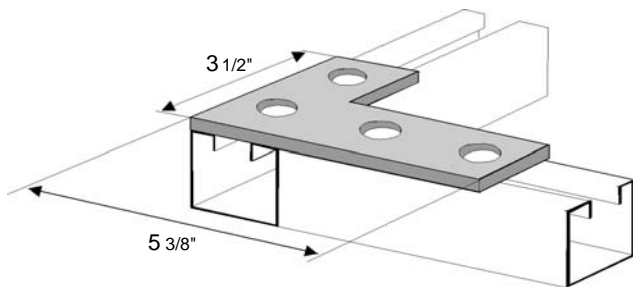

Wt./C 75 Lbs.  
Std. Pkg. 25 Pcs.

**Four-Hole Corner Gusset** **FP605**

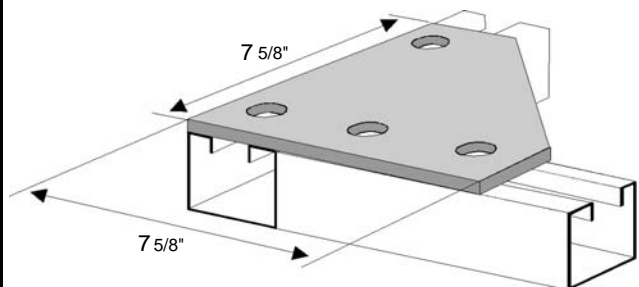

Wt./C 273 Lbs.  
Std. Pkg. 10 Pcs.

**FITTING SPECIFICATIONS** (unless noted): Hole Size-9/16" Diameter; Hole Spacing-13/16" from end and 1 7/8" on center.  
Width-1 5/8"; Thickness 1/4"

**FINISHES AVAILABLE:** Zinc Plated, Hot-Dipped Galvanized & Stainless Steel

**Five-Hole Cross Plate** **FP700**

Wt./C 100 Lbs.  
Std. Pkg. 10 Pcs.

**Five-Hole Tee Gusset** **FP701**

Wt./C 143 Lbs.  
Std. Pkg. 20 Pcs.

**Five-Hole Corner Gusset** **FP702**

Wt./C 145 Lbs.  
Std. Pkg. 20 Pcs.

**Six-Hole Tee Gusset** **FP800**

Wt./C 149 Lbs.  
Std. Pkg. 20 Pcs.

**Six-Hole Cross Gusset** **FP801**

Wt./C 166 Lbs.  
Std. Pkg. 20 Pcs.

**Seven-Hole Cross Gusset** **FP900**

Wt./C 232 Lbs.  
Std. Pkg. 15 Pcs.

**FITTING SPECIFICATIONS** (unless noted): Hole Size-9/16" Diameter; Hole Spacing-13/16" from end and 1 7/8" on center.  
Width-1 5/8"; Thickness 1/4"

**FINISHES AVAILABLE:** Zinc Plated, Hot-Dipped Galvanized & Stainless Steel